

Motor_Serial_Port_Driver

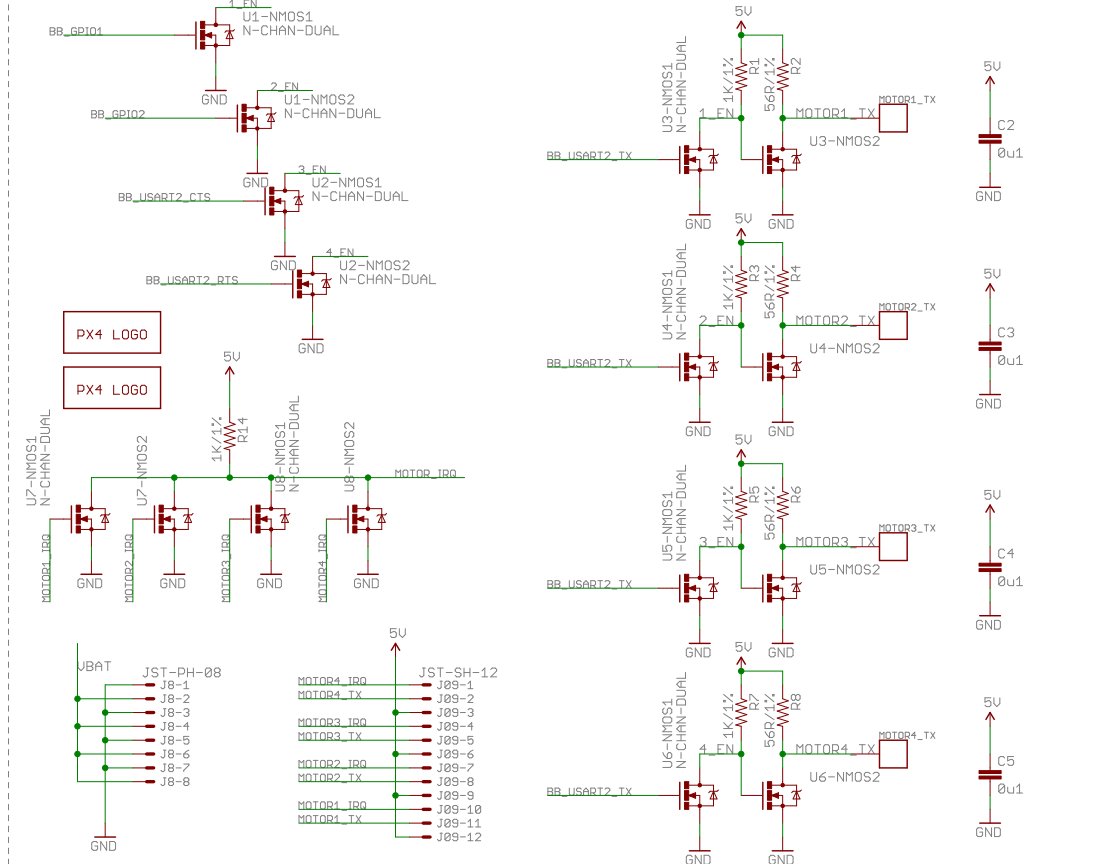

Power_Supply

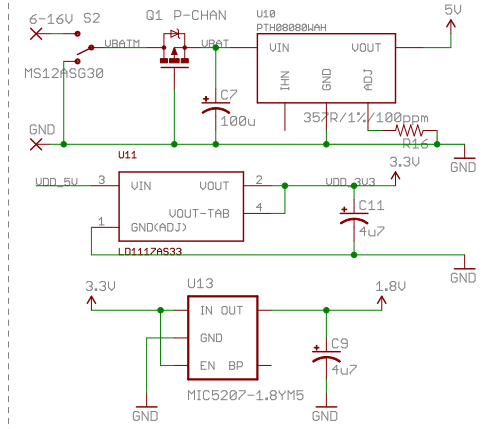

LEDs

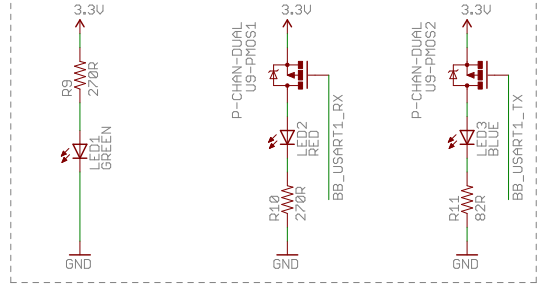

EEPROM

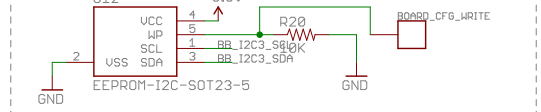

XBEE

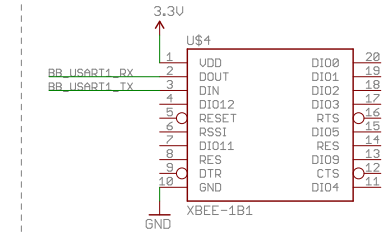

Production_testing_pads

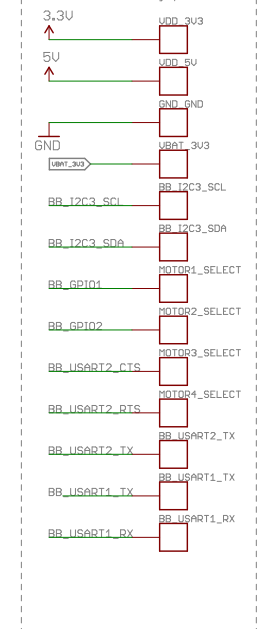

Voltage_Measurement

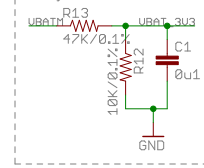

Wire_pads

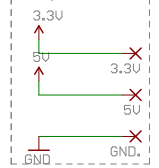

Expansion_Connector

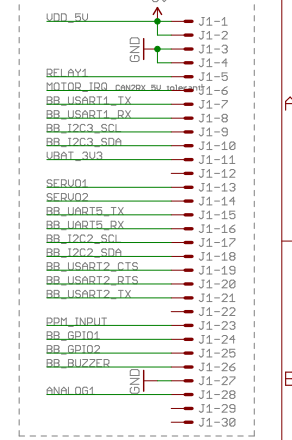

PPM_Input

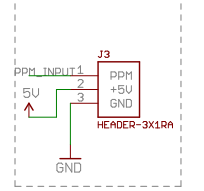

External_UART1

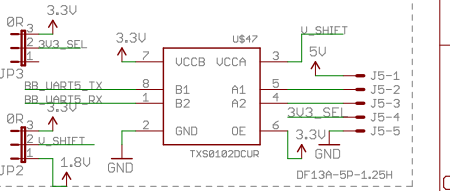

BUZZER

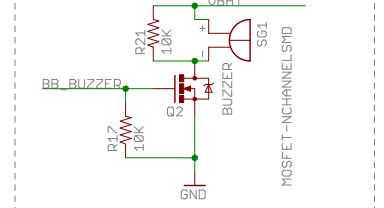

External_I2C_2

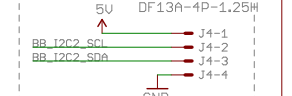

External_I2C_3

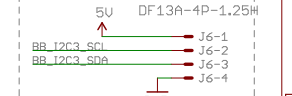

RELAY

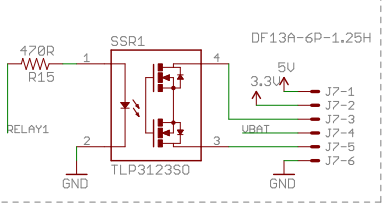

Mounting_holes_Parcot/IMU

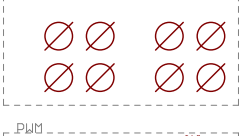

Mounting_holes_Flow_Boards

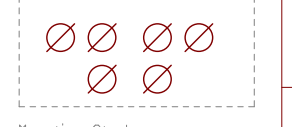

PPM

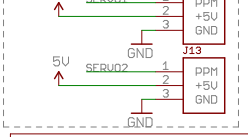

Mounting_Stack



ANALOG_Measurement

